

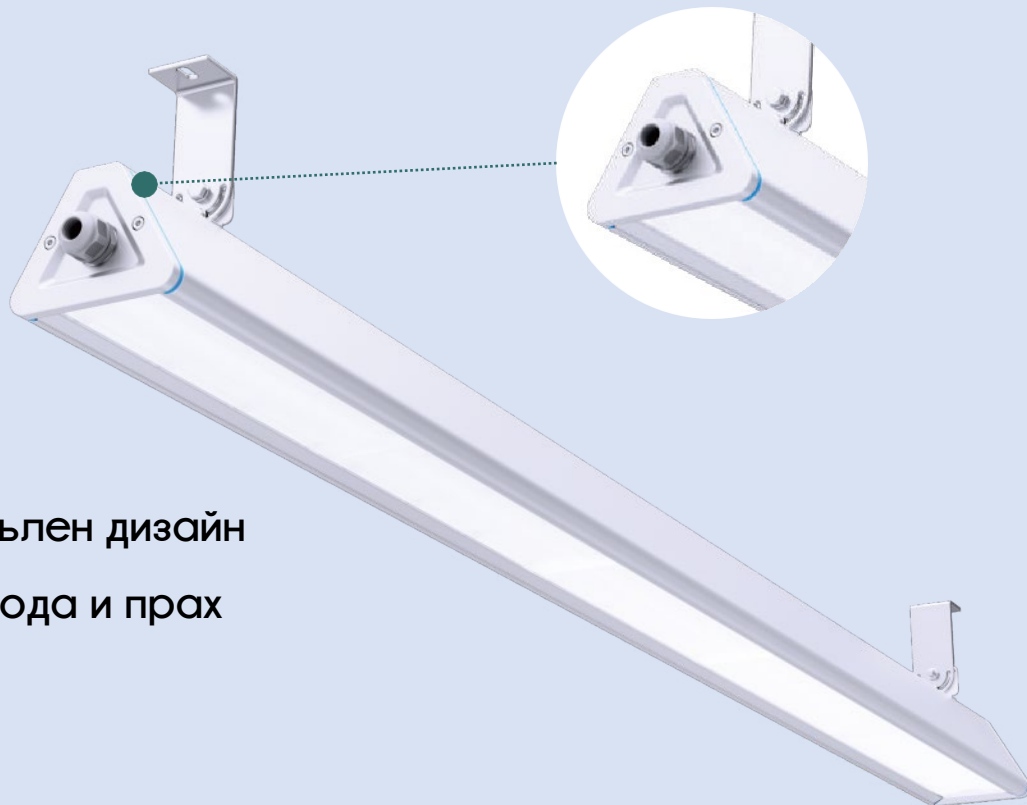

**industrial
lighting**



Eridan ALU | Linear
Series RV | Highbay
Light



**Уникален триъгълен дизайн
не задържащ вода и прах**

Естетично осветление

Индустриалният линеен алуминиев осветител е с дизайн на оптиката и печатните платки, създадени за постигане на уникален светлинен ефект.

Той не само повишава естетиката и разпределението на светлината, но и намалява заслепяването.

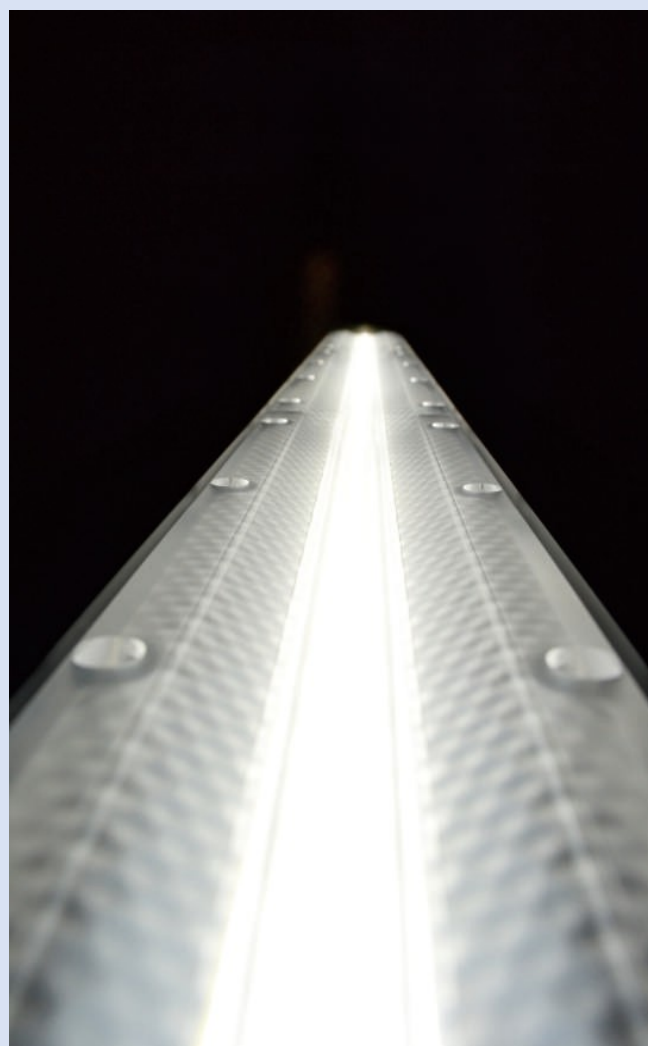

С терминал позволяващ лесно окабеляване и съответно ниски инсталационни разходи

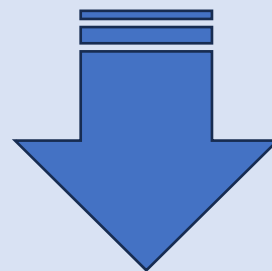
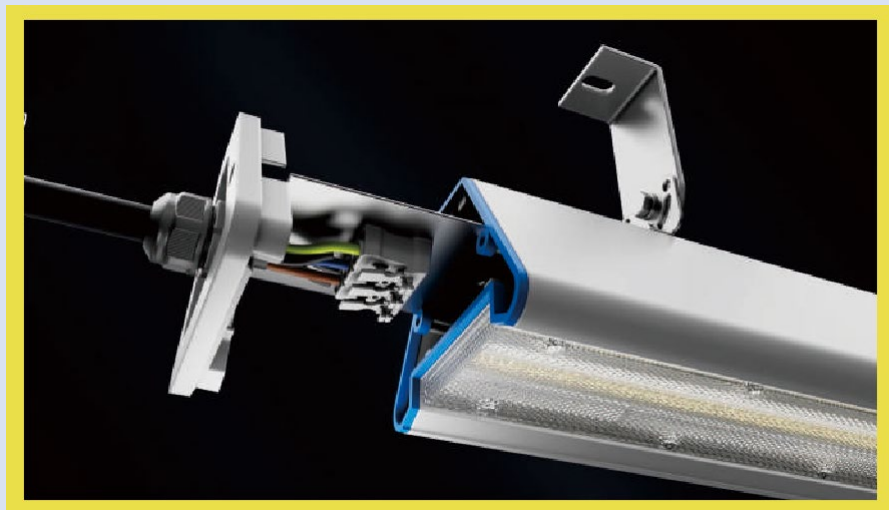

Кабелите отвътре дават възможност за свързване във верига

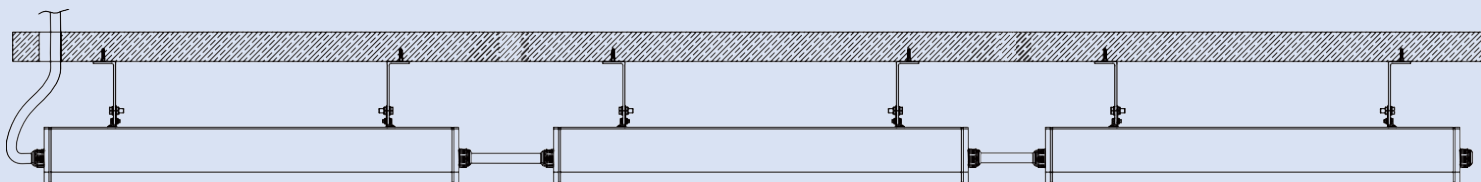
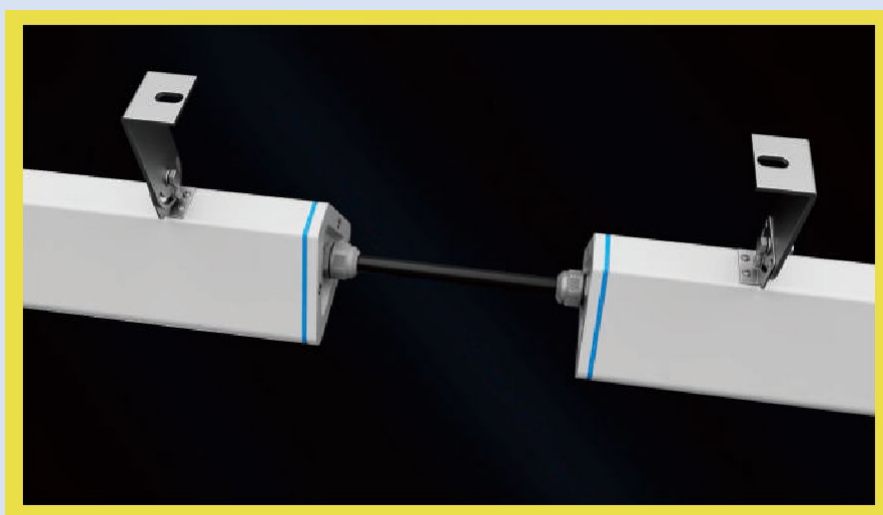
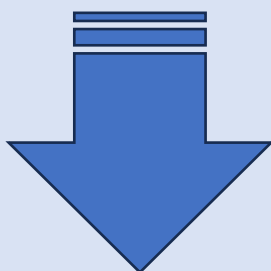

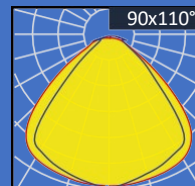
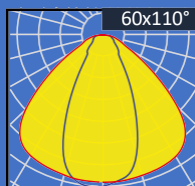
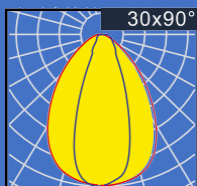

Най-добрият избор за складове и логистики.

Специално подобранияте оптики спестяват 30% от енергията в сравнение с кръглите осветители тип Хай бей, при които 30% от светлината се загубва в горните части на помещението.

Специално подобранияте оптики увеличават с 30% осветеността спрямо осветителите тип UFO.

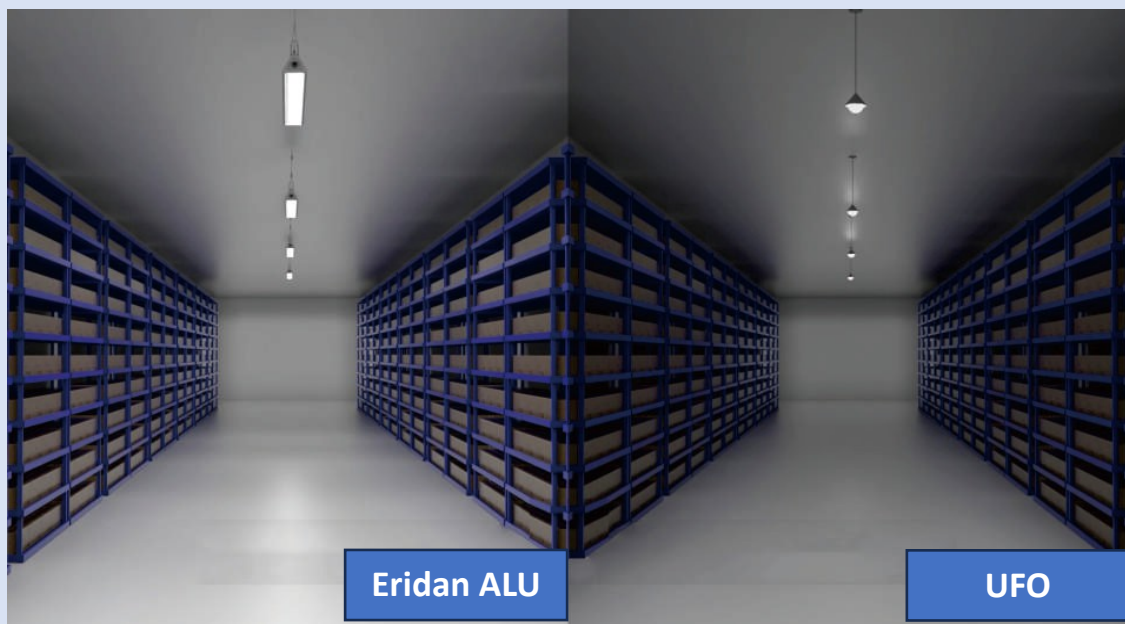

Ефективност

160 lm/W





Чист алуминиев корпус. По-добро топлоотдаване.



Степен на защита на корпуса IP66, означава че осветителя има пълна защита срещу проникване на прахови частици и е защитен от водна струя с високо налягане от всички посоки.

Несъмнено високата степен на защита на осветителя запазва вашите инвестиции, тя удължават живота му, като намалява разходите за поддръжка, причинени от влага или повреда.

ВИДОВЕ ИНСТАЛАЦИИ

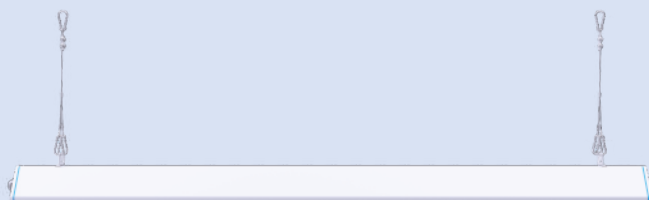

① Инсталация на въже



② Инсталация със скоби

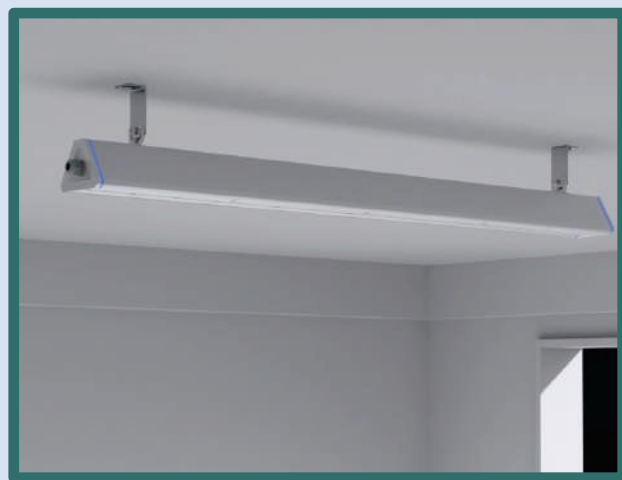

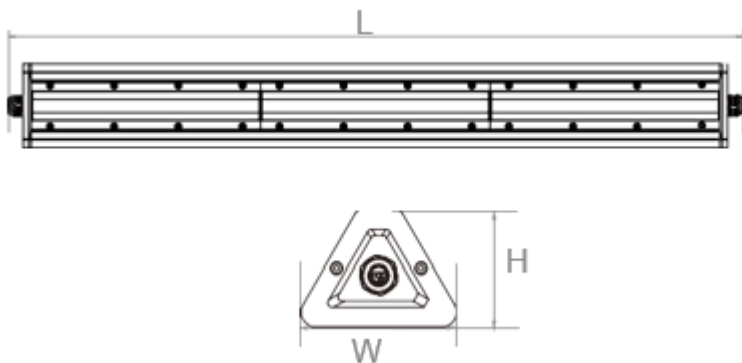

Допълнителни функции по заявка

ZigBee / PWM / DALI / 0/1-10V

Светоразпределение:

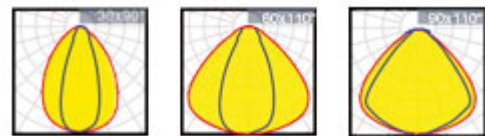

Характеристики

Корпус: Алуминий А6063
 Теплопроводимост: 226 W/mK
 Led: Philips
 CRI: Ra>80
 SDCM: <6
 Фактор на мощност: >0.95
 THD: <15
 Захранване: Sosen
 Ефективност на захр.: >92%
 Защити: OTP, OCP, OVP, SCP
 Защита от пренапрежение: 4KV
 Водоустойчивост: IP66
 Защита от удари: IK08
 Напрежение: 100~277V, 50/60Hz
 Работна температура: -25~45
 TM21: L90B10>50,000H
 Живот: 50,000H

МОДЕЛ	МОЩНОСТ	НАПРЕЖЕНИЕ	ЛУМЕНИ	CRI	IP	РАЗМЕРИ
Eridan ALU RV100W200-230	100W	100~277V	16000LM	>80	IP66	592*105.4*79mm
Eridan ALU RV150W250-230	150W	100~277V	24000LM	>80	IP66	892*105.4*79mm

ОПАКОВКА

Размери (mm)	Вътрешна опаковка(mm)	Бройка	Външна опаковка	Бройка	Нето	Бруто
592/105.4/79	///	1	680/385/310	4	12.50	16.20
892/105.4/79	///	1	980/390/310	4	14.00	23.70